

WALK-IN CLOSET MILLIMETRICA

WALK-IN CLOSET
MILLIMETRICA

WALK-IN CLOSET MILLIMETRICA





TECHNICAL INFORMATION WALK-IN CLOSET MILLIMETRICA

• TECHNICAL INFORMATION:

- Side panels:** Extra-light wooden agglomerate melamine coated thickness 38mm. Drilling holes \varnothing 3mm every 80mm. Supplied with pre-fitted adjustable feet and upper hardware fixtures. Side panels for walk-in closet with wall panels are prefitted with rear aluminium profile for the assembling of the wall panels. The profile is ready for wall-fitting.
- Bases:** Extra-light wooden agglomerate melamine coated thickness 38mm.; complete with 5mm feet adjustable in height for positioning on the floor.
- Shelves:** Extra-light wooden agglomerate melamine coated thickness 38mm; supplied with nickel-plated metal supports with locking screw to prevent overturning. Prepared for fitting of hanging rails, **which must be fitted before positioning the shelf.**
- Clothes rails:** nickel-plated tubular metal \varnothing 30mm, th.1mm; supplied with fixing hooks in die casted iron varnished aluminium with special screws for fitting on the shelves.
- Wall panels:** Extra-light wooden agglomerate melamine coated thickness 19mm or th.14+4mm for wall panels in glass. Complete with aluminium feet H.5mm adjustable in height for positioning on the floor. Terminal elements at sight, for walk-in closets with wall panels, are complete with a lateral closing profile.
- Chests of drawers and accessories:** in the same finishes as the walk-in closets, see chapters "Chests of drawers" and "Accessories". Chests of drawers can only be positioned on a shelf or base.

• DIMENSIONS:

- Heights::** H.2262 - 2422 - 2582 - 2902mm.
- Widths:** Modules W.400 - 480 - 560 - 800 - 960 - 1120mm.
- Depths:** Side panels D.304mm for walk-in closets without wall panel.
Side panels D.327mm for walk-in closets with wall panel.
Side panel for corner module without wall panel D.380/495mm.
Side panel for corner module with wall panel D.403/518mm.
Bases and shelves: D.380/495mm.

• LED LIGHTING PLANT:

Consult the Company for feasibility and costs.

• FINISHES:

- Side panels, bases, shelves:** Smooth melamine Gesso
Textured melamine Walnut
Textured melamine Greige
Melamine Brown
Melamine lacquered colours
- Clothes rails:** Chromed
- Wooden wall panels:** Smooth melamine Gesso
Textured melamine Walnut
Textured melamine Greige
Melamine Brown
Melamine lacquered colours
- Glass wall panels:** Varnished glass
Varnished frosted glass
Natural mirror
Bronzed mirror
Reflective glass varnished anthracite
- Chests of drawers:** Smooth melamine Gesso
Textured melamine Walnut
Textured melamine Greige
Melamine Brown
Melamine lacquered colours

• ASSEMBLING:

A minimum space of 30mm above the panels is required to allow assembling. Laterally a total space of 30mm is necessary.

• MADE TO MEASURE:

see chapter "Made to measure I-BOX"

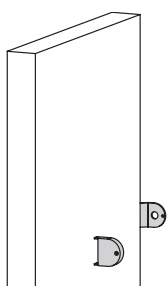

Hardware for wall fixing of walk-in closets without wall panels.

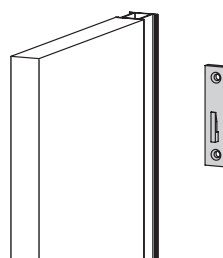

Hardware for wall fixing of walk-in closets with wall panels.

N.B. - Fixing to the wall is compulsory in both cases, to avoid overturning of the walk-in closet.

TECHNICAL INFORMATION WALK-IN CLOSET MILLIMETRICA

TO BUILD THE WALK-IN CLOSET:

Without wall panel

sum up all the modules + closing side panel th.38mm (side panel depth 304 + 10mm wall fixture)

With wall panel

sum up all the modules + closing side panel th.38mm (side panel depth 304 + 23 wall panel profile + 10mm wall fixture).

In case of corner module with wall panel, add to the width calculated 33mm for each corner module.

COMPOSITIONS WITHOUT WALL PANEL

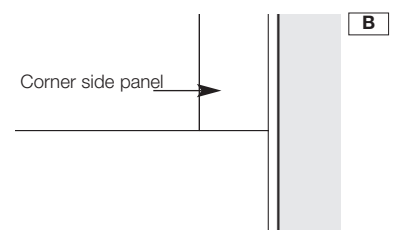
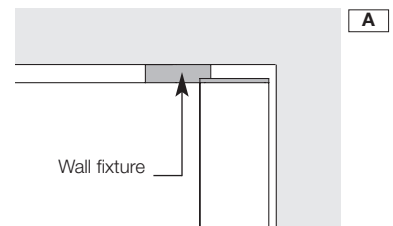
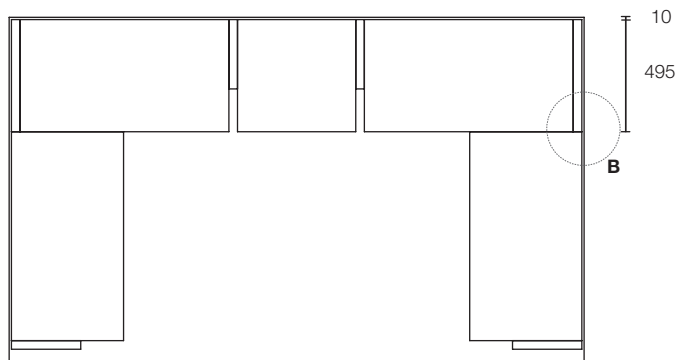
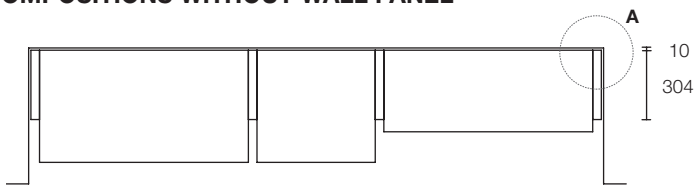

COMPOSITIONS WITH WALL PANEL

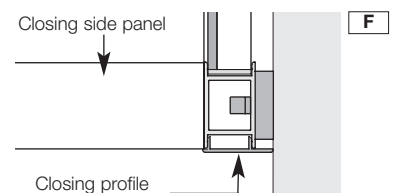
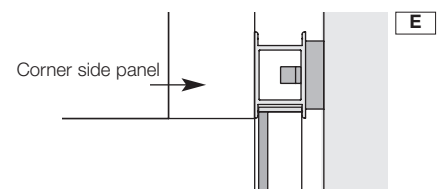
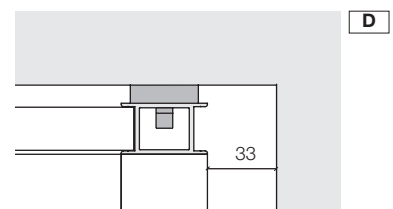
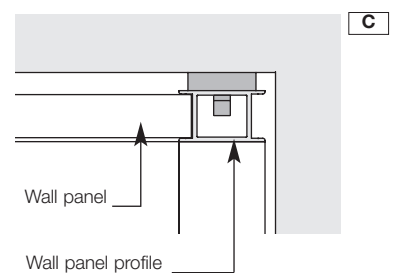
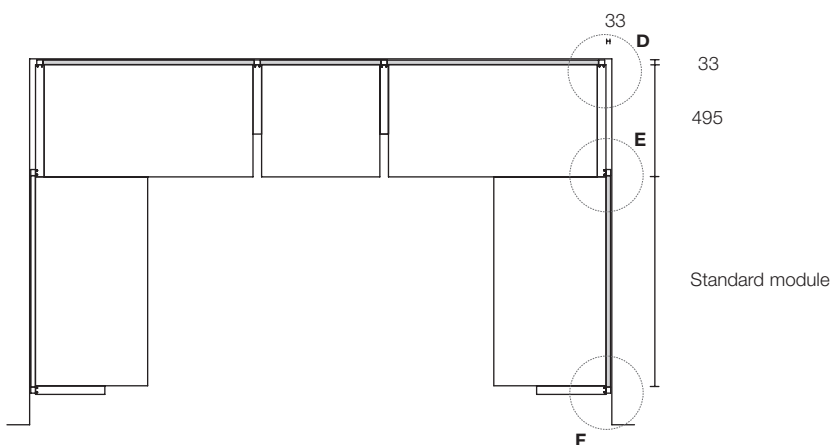
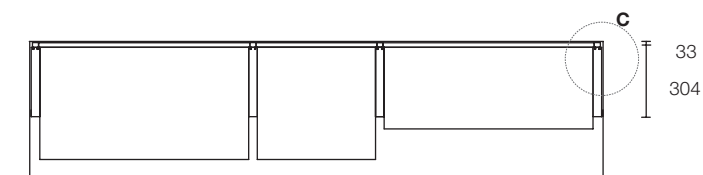

COMPONENTS WALK-IN CLOSET WITHOUT WALL PANEL

SIDE PANELS

Th.38mm.; D.304mm.
In melamine Gesso, Walnut, Greige, Brown or matt lacquered.
To be fixed to the wall.

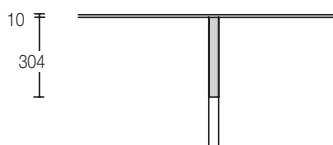
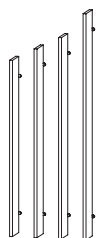

Melamine Gesso

H.2262 **SC6**
H.2422 **SC7**
H.2582 **SC8**
H.2902 **SC9**

Mel. Walnut/Greige/Brown

H.2262 **SC6**
H.2422 **SC7**
H.2582 **SC8**
H.2902 **SC9**

Matt lacquered

H.2262 **SC6**
H.2422 **SC7**
H.2582 **SC8**
H.2902 **SC9**

CORNER CLOSING SIDE PANELS FOR SHELVES D.495mm.

Th.38mm.; D.495mm. for shelves D.495mm.
In melamine Gesso, Walnut, Greige, Brown or matt lacquered.
To be fixed to the wall.

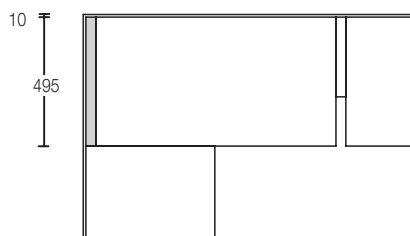
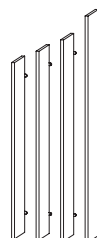

Melamine Gesso

H.2262 **SA65**
H.2422 **SA75**
H.2582 **SA85**
H.2902 **SA95**

Mel. Walnut/Greige/Brown

H.2262 **SA65**
H.2422 **SA75**
H.2582 **SA85**
H.2902 **SA95**

Matt lacquered

H.2262 **SA65**
H.2422 **SA75**
H.2582 **SA85**
H.2902 **SA95**

CORNER CLOSING SIDE PANELS FOR SHELVES D.380mm.

Th.38mm.; D.380mm. for shelves D.380mm.
In melamine Gesso, Walnut, Greige, Brown or matt lacquered.
To be fixed to the wall.

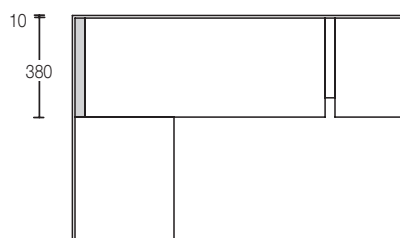
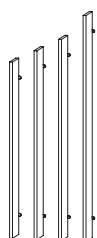

Melamine Gesso

H.2262 **SA64**
H.2422 **SA74**
H.2582 **SA84**
H.2902 **SA94**

Mel. Walnut/Greige/Brown

H.2262 **SA64**
H.2422 **SA74**
H.2582 **SA84**
H.2902 **SA94**

Matt lacquered

H.2262 **SA64**
H.2422 **SA74**
H.2582 **SA84**
H.2902 **SA94**

COMPONENTS WALK-IN CLOSET WITH WALL PANEL

SIDE PANELS

Th.38mm.; D.327mm.

In melamine Gesso, Walnut, Greige, Brown or matt lacquered.

To be fixed to the wall.

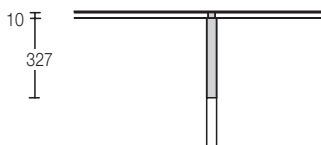
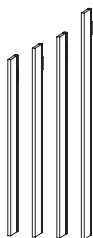

Melamine Gesso

H.2262 **SCP6**
H.2422 **SCP7**
H.2582 **SCP8**
H.2902 **SCP9**

Mel. Walnut/Greige/Brown

H.2262 **SCP6**
H.2422 **SCP7**
H.2582 **SCP8**
H.2902 **SCP9**

Matt lacquered

H.2262 **SCP6**
H.2422 **SCP7**
H.2582 **SCP8**
H.2902 **SCP9**

CORNER CLOSING SIDE PANELS FOR SHELVES D.495mm.

Th.38mm.; D.518mm. for shelves D.495mm.

In melamine Gesso, Walnut, Greige, Brown or matt lacquered.

To be fixed to the wall.

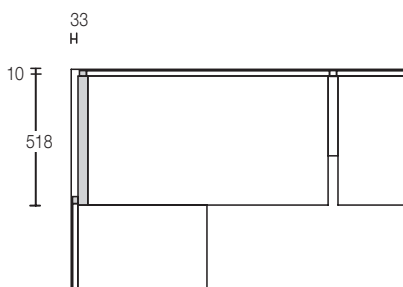
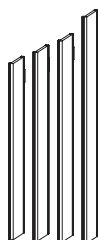

Melamine Gesso

H.2262 **SAP65**
H.2422 **SAP75**
H.2582 **SAP85**
H.2902 **SAP95**

Mel. Walnut/Greige/Brown

H.2262 **SAP65**
H.2422 **SAP75**
H.2582 **SAP85**
H.2902 **SAP95**

Matt lacquered

H.2262 **SAP65**
H.2422 **SAP75**
H.2582 **SAP85**
H.2902 **SAP95**

CORNER CLOSING SIDE PANELS FOR SHELVES D.380mm.

Th.38mm.; D.403mm. for shelves D.380mm.

In melamine Gesso, Walnut, Greige, Brown or matt lacquered.

To be fixed to the wall.

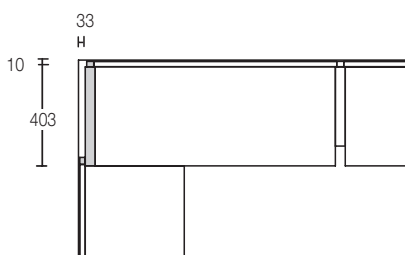
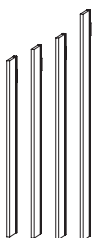

Melamine Gesso

H.2262 **SAP64**
H.2422 **SAP74**
H.2582 **SAP84**
H.2902 **SAP94**

Mel. Walnut/Greige/Brown

H.2262 **SAP64**
H.2422 **SAP74**
H.2582 **SAP84**
H.2902 **SAP94**

Matt lacquered

H.2262 **SAP64**
H.2422 **SAP74**
H.2582 **SAP84**
H.2902 **SAP94**

COMPONENTS

WALK-IN CLOSET MILLIMETRICA

BASES

Thickness 38 + 5mm.

In melamine Gesso, Walnut, Greige, Brown or matt lacquered.

Complete with aluminium feet adjustable in height.

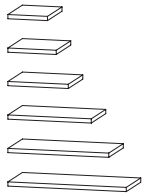

Melamine Gesso	W. 362
	W. 442
	W. 522
	W. 762
	W. 922
	W.1082
Mel. Walnut/Greige/Brown	W. 362
	W. 442
	W. 522
	W. 762
	W. 922
	W.1082
Matt lacquered	W. 362
	W. 442
	W. 522
	W. 762
	W. 922
	W.1082

D.495

D.380

CB52	CB42
CB53	CB43
CB54	CB44
CB56	CB46
CB57	CB47
CB58	CB48
CB52	CB42
CB53	CB43
CB54	CB44
CB56	CB46
CB57	CB47
CB58	CB48
CB52	CB42
CB53	CB43
CB54	CB44
CB56	CB46
CB57	CB47
CB58	CB48

SHELVES

Thickness 38mm.

In melamine Gesso, Walnut, Greige, Brown or matt lacquered.

Complete with anti-tumbling shelf supports for fixing to side panels.

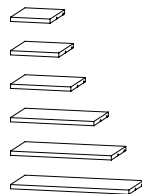

Melamine Gesso	W. 362
	W. 442
	W. 522
	W. 762
	W. 922
	W.1082
Mel. Walnut/Greige/Brown	W. 362
	W. 442
	W. 522
	W. 762
	W. 922
	W.1082
Matt lacquered	W. 362
	W. 442
	W. 522
	W. 762
	W. 922
	W.1082

CR52	CR42
CR53	CR43
CR54	CR44
CR56	CR46
CR57	CR47
CR58	CR48
CR52	CR42
CR53	CR43
CR54	CR44
CR56	CR46
CR57	CR47
CR58	CR48
CR52	CR42
CR53	CR43
CR54	CR44
CR56	CR46
CR57	CR47
CR58	CR48

ROD

to be fitted on the front edge of a shelf. Chrome finish.



A40

CLOTHES RAILS

Ø 30mm.

In nickel-plated metal, complete with fixing hooks. Maximum weight capacity 30kg. Use of an upper shelf is required.

Rails must be fitted on the shelf before its positioning.



W. 362	TP2
W. 442	TP3
W. 522	TP4
W. 762	TP6
W. 922	TP7
W.1082	TP8

CLOTHES LIFT

Fixing plates in neutral colour, chromed rails.

Maximum weight capacity 10kg.



W. 762	A36
W. 922	A37
W.1082	A38

WALL PANELS

WALK-IN CLOSET MILLIMETRICA

WALL PANELS

Thickness 19mm.

In melamine Gesso, Walnut, Greige, Brown or matt lacquered.

To be inserted in the rear profile of the side panel.

Complete with adjustable feet.

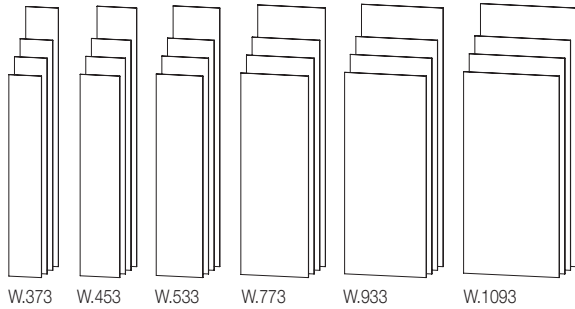

Th.19



	H.2262	H.2422	H.2582	H.2902
Melamine Gesso				
W. 373	P26	P27	P28	P29
W. 453	P36	P37	P38	P39
W. 533	P46	P47	P48	P49
W. 773	P66	P67	P68	P69
W. 933	P76	P77	P78	P79
W.1093	P86	P87	P88	P89
Melamine Walnut/Greige/Brown				
W. 373	P26	P27	P28	P29
W. 453	P36	P37	P38	P39
W. 533	P46	P47	P48	P49
W. 773	P66	P67	P68	P69
W. 933	P76	P77	P78	P79
W.1093	P86	P87	P88	P89
Matt lacquered				
W. 373	P26	P27	P28	P29
W. 453	P36	P37	P38	P39
W. 533	P46	P47	P48	P49
W. 773	P66	P67	P68	P69
W. 933	P76	P77	P78	P79
W.1093	P86	P87	P88	P89
Lateral closing profile	PK6	PK7	PK8	PK9

WALL GLASS PANELS

Thickness 14 + 4mm.

To be inserted in the rear profile of the side panel.

Complete with adjustable feet.

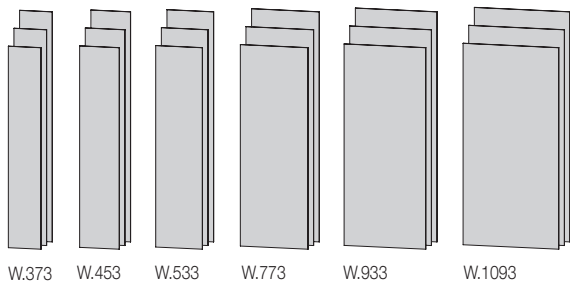

Th.14 + 4



Varnished glass				
W. 373	PV26	PV27	PV28	
W. 453	PV36	PV37	PV38	
W. 533	PV46	PV47	PV48	
W. 773	PV66	PV67	PV68	
W. 933	PV76	PV77	PV78	
W.1093	PV86	PV87	PV88	
Varnished frosted glass				
W. 373	PV26	PV27	PV28	
W. 453	PV36	PV37	PV38	
W. 533	PV46	PV47	PV48	
W. 773	PV66	PV67	PV68	
W. 933	PV76	PV77	PV78	
W.1093	PV86	PV87	PV88	
Reflective glass varn. anthracite				
W. 373	PV26	PV27	PV28	
W. 453	PV36	PV37	PV38	
W. 533	PV46	PV47	PV48	
W. 773	PV66	PV67	PV68	
W. 933	PV76	PV77	PV78	
W.1093	PV86	PV87	PV88	
Natural / bronzed mirror				
W. 373	PV26	PV27	PV28	
W. 453	PV36	PV37	PV38	
W. 533	PV46	PV47	PV48	
W. 773	PV66	PV67	PV68	
W. 933	PV76	PV77	PV78	
W.1093	PV86	PV87	PV88	
Lateral closing profile	PK6	PK7	PK8	

MODULES H.2262mm

WALK-IN CLOSET MILLIMETRICA

W.400 W.480 W.560 W.800 W.960 W.1120

MODULES WITHOUT WALL PANELS – SHELVES D.495

MODULE D.505

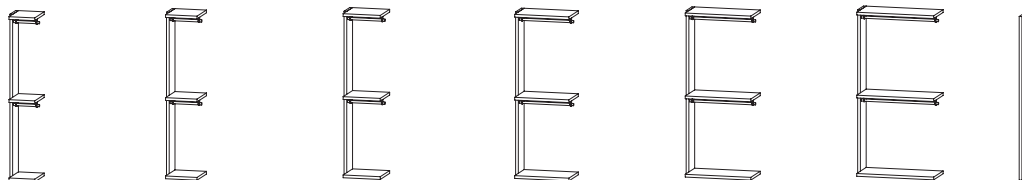

Code

M62A M63A M64A M66A M67A M68A SC6

Melamine Gesso
Mel. Walnut/Greige/Brown
Matt lacquered

MODULE D.505

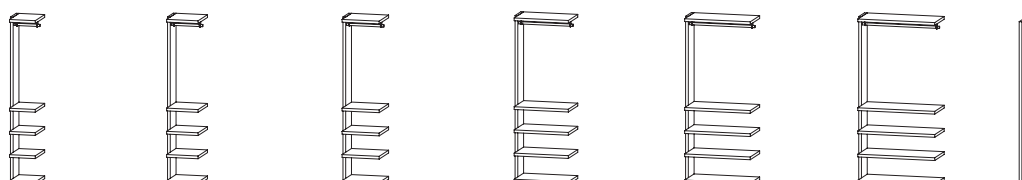

Code

M62B M63B M64B M66B M67B M68B SC6

Melamine Gesso
Mel. Walnut/Greige/Brown
Matt lacquered

MODULES WITH WALL PANELS SAME FINISH – SHELVES D.495

MODULE D.528

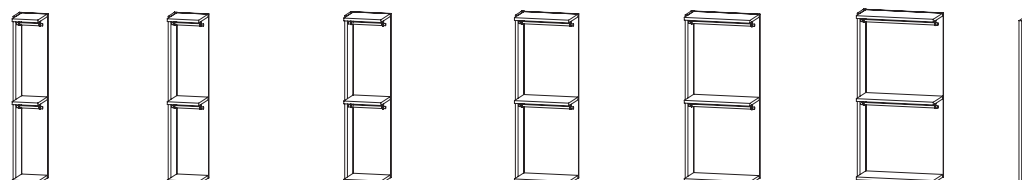

Code

MP62A MP63A MP64A MP66A MP67A MP68A SCP6

Melamine Gesso
Mel. Walnut/Greige/Brown
Matt lacquered

MODULE D.528

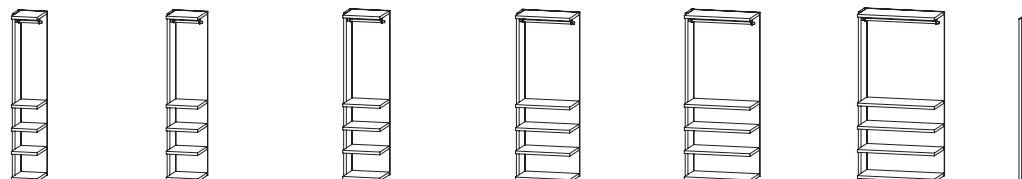

Code

MP62B MP63B MP64B MP66B MP67B MP68B SCP6

Melamine Gesso
Mel. Walnut/Greige/Brown
Matt lacquered

MODULES H.2422mm

WALK-IN CLOSET MILLIMETRICA

W.400 W.480 W.560 W.800 W.960 W.1120

MODULES WITHOUT WALL PANELS – SHELVES D.495

MODULE D.505

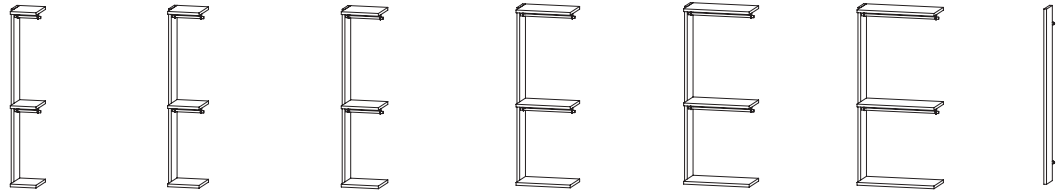

Code	M72A	M73A	M74A	M76A	M77A	M78A	SC7
------	------	------	------	------	------	------	-----

Melamine Gesso
Mel. Walnut/Greige/Brown
Matt lacquered

MODULE D.505

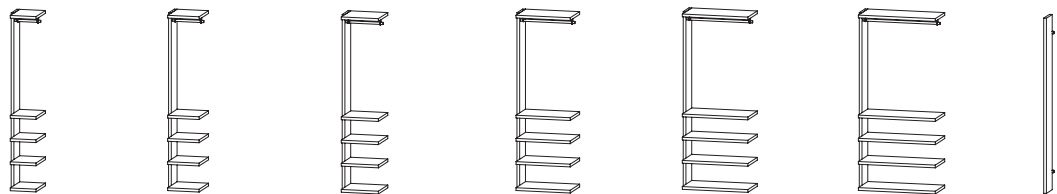

Code	M72B	M73B	M74B	M76B	M77B	M78B	SC7
------	------	------	------	------	------	------	-----

Melamine Gesso
Mel. Walnut/Greige/Brown
Matt lacquered

MODULES WITH WALL PANELS SAME FINISH – SHELVES D.495

MODULE D.528

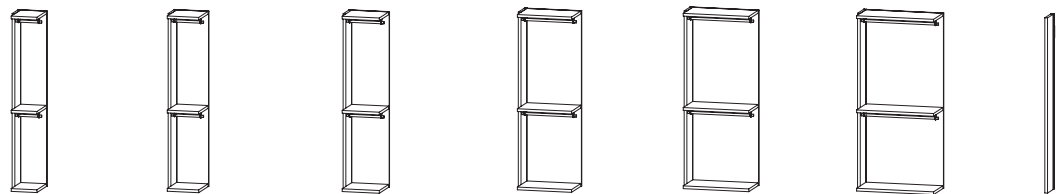

Code	MP72A	MP73A	MP74A	MP76A	MP77A	MP78A	SCP7
------	-------	-------	-------	-------	-------	-------	------

Melamine Gesso
Mel. Walnut/Greige/Brown
Matt lacquered

MODULE D.528

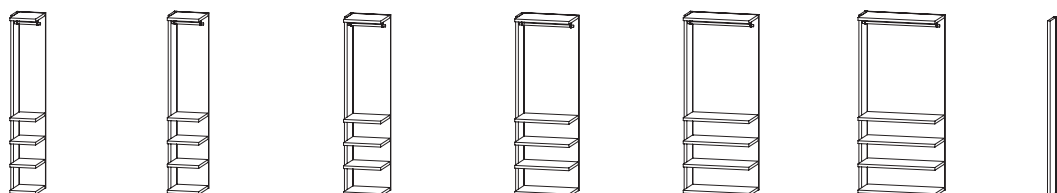

Code	MP72B	MP73B	MP74B	MP76B	MP77B	MP78B	SCP7
------	-------	-------	-------	-------	-------	-------	------

Melamine Gesso
Mel. Walnut/Greige/Brown
Matt lacquered

MODULES H.2582mm

WALK-IN CLOSET MILLIMETRICA

W.400 W.480 W.560 W.800 W.960 W.1120

MODULES WITHOUT WALL PANELS – SHELVES D.495

MODULE D.505

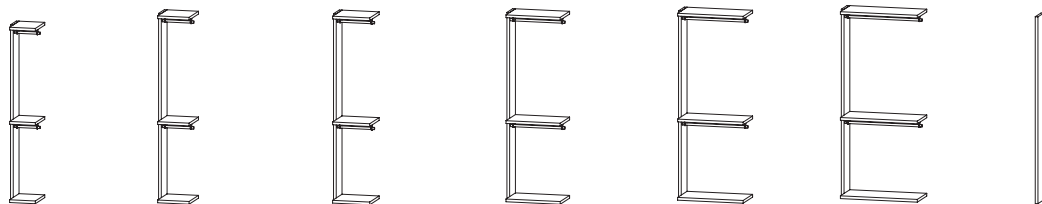

Code

M82A M83A M84A M86A M87A M88A SC8

Melamine Gesso
Mel. Walnut/Greige/Brown
Matt lacquered

MODULE D.505

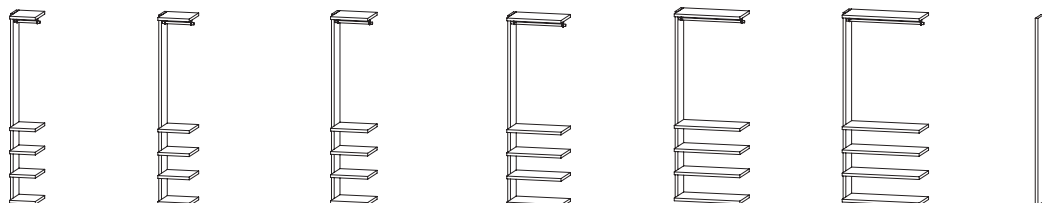

Code

M82B M83B M84B M86B M87B M88B SC8

Melamine Gesso
Mel. Walnut/Greige/Brown
Matt lacquered

MODULES WITH WALL PANELS SAME FINISH – SHELVES D.495

MODULE D.528

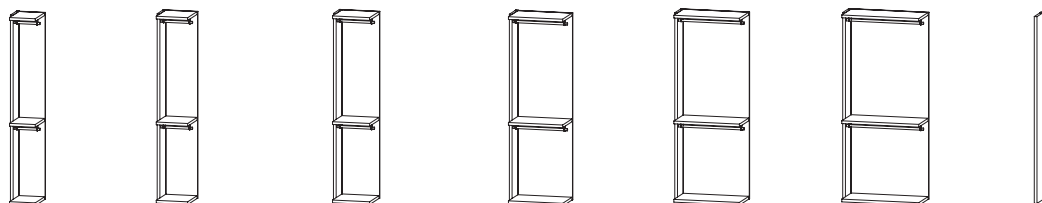

Code

MP82A MP83A MP84A MP86A MP87A MP88A SCP8

Melamine Gesso
Mel. Walnut/Greige/Brown
Matt lacquered

MODULE D.528

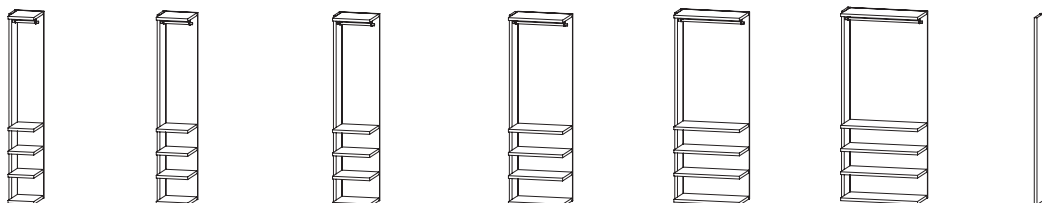

Code

MP82B MP83B MP84B MP86B MP87B MP88B SCP8

Melamine Gesso
Mel. Walnut/Greige/Brown
Matt lacquered

MODULES H.2902mm

WALK-IN CLOSET MILLIMETRICA

W.400 W.480 W.560 W.800 W.960 W.1120

MODULES WITHOUT WALL PANELS – SHELVES D.495

MODULE D.505

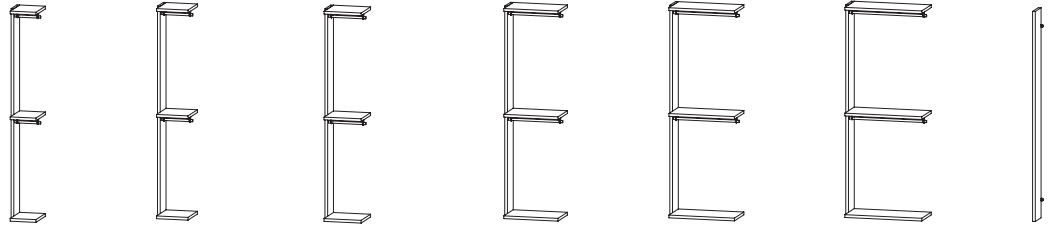

Code

M92A M93A M94A M96A M97A M98A SC9

Melamine Gesso
Mel. Walnut/Greige/Brown
Matt lacquered

MODULE D.505

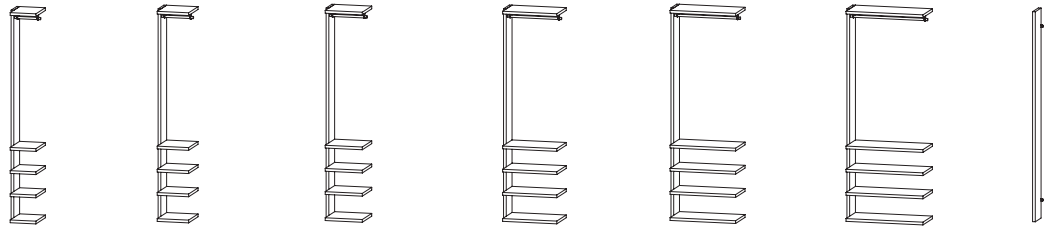

Code

M92B M93B M94B M96B M97B M98B SC9

Melamine Gesso
Mel. Walnut/Greige/Brown
Matt lacquered

MODULES WITH WALL PANELS SAME FINISH – SHELVES D.495

MODULE D.528

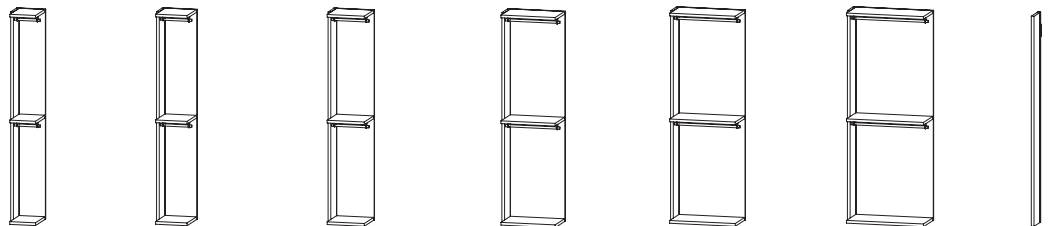

Code

MP92A MP93A MP94A MP96A MP97A MP98A SCP9

Melamine Gesso
Mel. Walnut/Greige/Brown
Matt lacquered

MODULE D.528

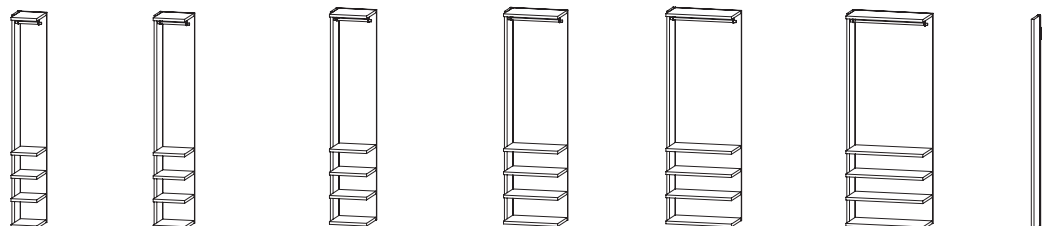

Code

MP92B MP93B MP94B MP96B MP97B MP98B SCP9

Melamine Gesso
Mel. Walnut/Greige/Brown
Matt lacquered

INTERNAL CHESTS OF DRAWERS I-BOX / MILLIMETRICA

STRUCTURES	5 widths 5 heights 1 depth	522 / 762 / 922 / 1082 / 1402 mm. 364 / 524 / 684 / 1004 / 1324 mm. 495 mm.
DRAWERS	6 types	Wooden front Glass front (transparent with mirrored frame on finish Gesso and Greige, transparent on finish Walnut) Tray Wooden front+thick leather Glass front +thick leather Tray+thick leather
	3 widths 2 heights	453 / 693 / 853 mm. 156 / 316 mm.
	Internally and externally in the same finish.	
HANDLES	Chromed handle (on finish Gesso, Greige and Brown) Wooden handle (on finish Walnut)	

TYPE OF DRAWERS	H.160 WOODEN FRONT	H.316 WOODEN FRONT	H.160 GLASS FRONT WITH MIRRORED FRAME	H.160 TRANSPARENT GLASS FRONT	H.160 TRAY	CHROMED HANDLE	WOODEN HANDLE	THICK LEATHER COVER
MELAMINE GESSO								
MELAMINE GREIGE								
MELAMINE BROWN								
MELAMINE WALNUT								

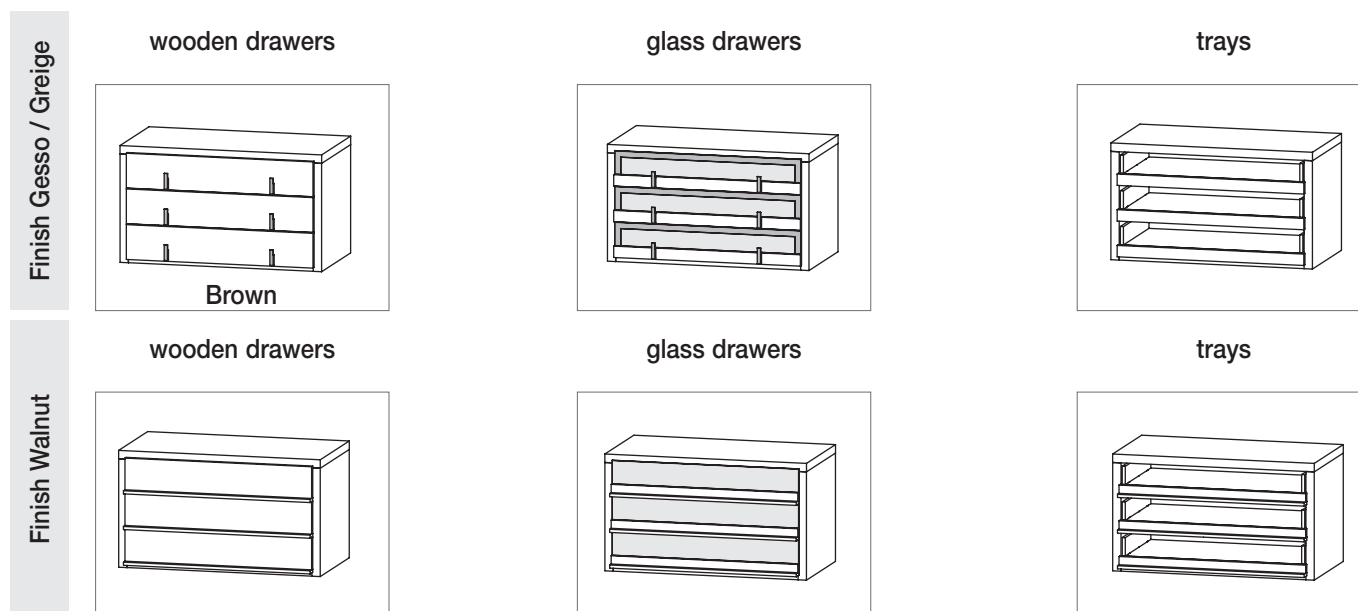

DRAWERS/
ACCESSORIES

Technical information

Side panels/top	Thickness 38mm.
Drawers' fronts	Thickness 19mm.
Inside of the drawer	Frame (th.14mm) and bottom (th.8mm) in melamine same finish as the structure (Gesso, Greige, Walnut). Drawers run on invisible steel runners with spring closing system. Maximum weight capacity 20kg.
Handles	On melamine Gesso and Greige, in casted iron with a chrome finish. On melamine Walnut handle in the same finish, same width as the drawer
Glasses	Tempered th.4mm. Transparent glass with 30mm mirrored frame for finish melamine Gesso and Greige Transparent glass for finish melamine Walnut

Chests of drawers are delivered disassembled (can be placed inside of a wardrobe also when doors are already in place).
CANNOT BE MADE TO MEASURE.

INTERNAL CHESTS OF DRAWERS I-BOX / MILLIMETRICA

See first page of the chapter for technical characteristics.

W.522

H.364



Wood Thick leather



Glass Thick leather



Wood/Glass Thick leather

Code

CK42A CK42AC

CK42B CK42BC

CK42C CK42CC

Melamine Gesso
Melamine Greige
Melamine Brown
Melamine Walnut

H.524



Wood Thick leather



Glass Thick leather



Wood/Glass Thick leather

Code

CK43A CK43AC

CK43B CK43BC

CK43C CK43CC

Melamine Gesso
Melamine Greige
Melamine Brown
Melamine Walnut

H.684



Wood Thick leather



Glass Thick leather



Wood/Glass Thick leather

Code

CK45A CK45AC

CK45B CK45BC

CK45C CK45CC

Melamine Gesso
Melamine Greige
Melamine Brown
Melamine Walnut

H.1004



Wood Thick leather



Glass Thick leather



Wood/Glass Thick leather

Code

CK47A CK47AC

CK47B CK47BC

CK47C CK47CC

Melamine Gesso
Melamine Greige
Melamine Brown
Melamine Walnut

H.1324

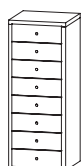

Wood Thick leather



Glass Thick leather



Wood/Glass Thick leather

Code

CK49A CK49AC

CK49B CK49BC

CK49C CK49CC

Melamine Gesso
Melamine Greige
Melamine Brown
Melamine Walnut

W.762



Wood Thick leather

CK62A CK62AC



Glass Thick leather

CK62B CK62BC



Wood/Glass Thick leather

CK62C CK62CC



Wood Thick leather

CK63A CK63AC



Glass Thick leather

CK63B CK63BC



Wood/Glass Thick leather

CK63C CK63CC



Wood Thick leather

CK65A CK65AC



Glass Thick leather

CK65B CK65BC



Wood/Glass Thick leather

CK65C CK65CC



Wood Thick leather

CK67A CK67AC



Glass Thick leather

CK67B CK67BC



Wood/Glass Thick leather

CK67C CK67CC

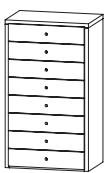

Wood Thick leather

CK69A CK69AC



Glass Thick leather

CK69B CK69BC



Wood/Glass Thick leather

CK69C CK69CC

INTERNAL CHESTS OF DRAWERS I-BOX / MILLIMETRICA

See first page of the chapter for technical characteristics.

W.922

H.364



Wood Thick leather



Glass Thick leather



Wood/Glass Thick leather

Code

CK72A CK72AC

CK72B CK72BC

CK72C CK72CC

Melamine Gesso
Melamine Greige
Melamine Brown
Melamine Walnut

H.524



Wood Thick leather



Glass Thick leather



Wood/Glass Thick leather

Code

CK73A CK73AC

CK73B CK73BC

CK73C CK73CC

Melamine Gesso
Melamine Greige
Melamine Brown
Melamine Walnut

H.684



Wood Thick leather



Glass Thick leather



Wood/Glass Thick leather

Code

CK75A CK75AC

CK75B CK75BC

CK75C CK75CC

Melamine Gesso
Melamine Greige
Melamine Brown
Melamine Walnut

H.1004

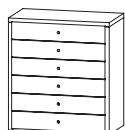

Wood Thick leather



Glass Thick leather



Wood/Glass Thick leather

Code

CK77A CK77AC

CK77B CK77BC

CK77C CK77CC

Melamine Gesso
Melamine Greige
Melamine Brown
Melamine Walnut

H.1324

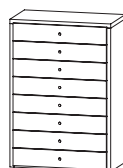

Wood Thick leather



Glass Thick leather



Wood/Glass Thick leather

Code

CK79A CK79AC

CK79B CK79BC

CK79C CK79CC

Melamine Gesso
Melamine Greige
Melamine Brown
Melamine Walnut

W.1082

only for modules I-BOX



Wood Thick leather

CK82A CK82AC

only for modules I-BOX



Glass Thick leather

CK82B CK82BC

only for modules I-BOX



Wood/Glass Thick leather

CK82C CK82CC

only for modules I-BOX

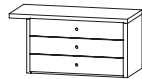

Wood Thick leather

CK83A CK83AC

only for modules I-BOX

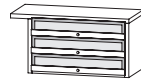

Glass Thick leather

CK83B CK83BC

only for modules I-BOX



Wood/Glass Thick leather

CK83C CK83CC

only for modules I-BOX



Wood Thick leather

CK85A CK85AC

only for modules I-BOX

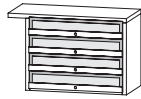

Glass Thick leather

CK85B CK85BC

only for modules I-BOX



Wood/Glass Thick leather

CK85C CK85CC

only for modules I-BOX



Wood Thick leather

CK87A CK87AC

only for modules I-BOX



Glass Thick leather

CK87B CK87BC

only for modules I-BOX



Wood/Glass Thick leather

CK87C CK87CC

only for modules I-BOX



Wood Thick leather

CK89A CK89AC

only for modules I-BOX



Glass Thick leather

CK89B CK89BC

only for modules I-BOX



Wood/Glass Thick leather

CK89C CK89CC

INTERNAL CHESTS OF DRAWERS I-BOX / MILLIMETRICA

See first page of the chapter for technical characteristics.

W.1082

H.364



Wood Thick leather



Glass Thick leather



Wood/Glass Thick leather

Code

CK82D CK82DC

CK82E CK82EC

CK82F CK82FC

Melamine Gesso
Melamine Greige
Melamine Brown
Melamine Walnut

H.524



Wood Thick leather



Glass Thick leather



Wood/Glass Thick leather

Code

CK83D CK83DC

CK83E CK83EC

CK83F CK83FC

Melamine Gesso
Melamine Greige
Melamine Brown
Melamine Walnut

H.684



Wood Thick leather



Glass Thick leather



Wood/Glass Thick leather

Code

CK85D CK85DC

CK85E CK85EC

CK85F CK85FC

Melamine Gesso
Melamine Greige
Melamine Brown
Melamine Walnut

H.1004



Wood Thick leather



Glass Thick leather



Wood/Glass Thick leather

Code

CK87D CK87DC

CK87E CK87EC

CK87F CK87FC

Melamine Gesso
Melamine Greige
Melamine Brown
Melamine Walnut

H.1324



Wood Thick leather



Glass Thick leather



Wood/Glass Thick leather

Code

CK89D CK89DC

CK89E CK89EC

CK89F CK89FC

Melamine Gesso
Melamine Greige
Melamine Brown
Melamine Walnut

INTERNAL CHESTS OF DRAWERS I-BOX

See first page of the chapter for technical characteristics.

W.1402

H.364



Wood Thick leather

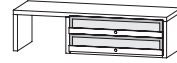

Glass Thick leather

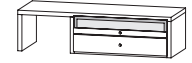

Wood/Glass Thick leather

Code

CK102A

CK102AC

CK102B

CK102BC

CK102C

CK102CC

Melamine Gesso
Melamine Greige
Melamine Brown
Melamine Walnut

H.524



Wood Thick leather



Glass Thick leather

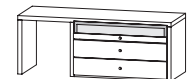

Wood/Glass Thick leather

Code

CK103A

CK103AC

CK103B

CK103BC

CK103C

CK103CC

Melamine Gesso
Melamine Greige
Melamine Brown
Melamine Walnut

H.684



Wood Thick leather

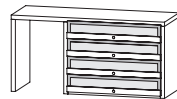

Glass Thick leather

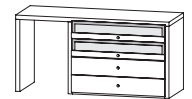

Wood/Glass Thick leather

Code

CK105A

CK105AC

CK105B

CK105BC

CK105C

CK105CC

Melamine Gesso
Melamine Greige
Melamine Brown
Melamine Walnut

H.1004

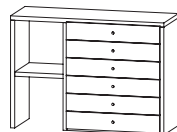

Wood Thick leather

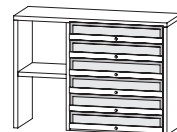

Glass Thick leather

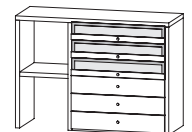

Wood/Glass Thick leather

Code

CK107A

CK107AC

CK107B

CK107BC

CK107C

CK107CC

Melamine Gesso
Melamine Greige
Melamine Brown
Melamine Walnut

H.1324



Wood Thick leather



Glass Thick leather



Wood/Glass Thick leather

Code

CK109A

CK109AC

CK109B

CK109BC

CK109C

CK109CC

Melamine Gesso
Melamine Greige
Melamine Brown
Melamine Walnut

STRUCTURES INT. CHESTS OF DRAWERS I-BOX/MILLIMETRICA

See first page of the chapter for technical characteristics.

* Lacquer finish only for Millimetrica lacquered

W.522

W.762

H.364

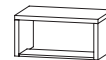

Code	K42	K42L *	K62	K62L *
Melamine Gesso				
Melamine Greige / Brown				
Melamine Walnut				

H.524

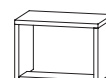

Code	K43	K43L *	K63	K63L *
Melamine Gesso				
Melamine Greige / Brown				
Melamine Walnut				

H.684

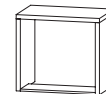

Code	K45	K45L *	K65	K65L *
Melamine Gesso				
Melamine Greige / Brown				
Melamine Walnut				

H.1004

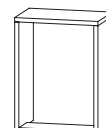
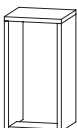

Code	K47	K47L *		*
Melamine Gesso				
Melamine Greige / Brown				
Melamine Walnut				

H.1324

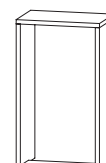
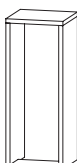

Code	K49	K49L *	K69	K69L *
Melamine Gesso				
Melamine Greige / Brown				
Melamine Walnut				

W.922

W.1082

W.1402

only for modules I-BOX

only for modules I-BOX

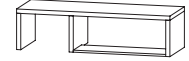
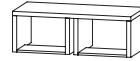
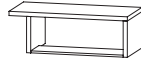

K72 K72L *

K872

K8442 K8442L *

K1072

only for modules I-BOX

only for modules I-BOX

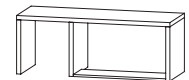
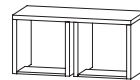
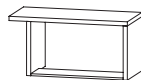
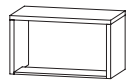

K73 K73L *

K873

K8443 K8443L *

K1073

only for modules I-BOX

only for modules I-BOX

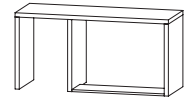
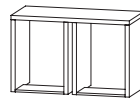
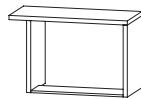
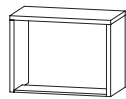

K75 K75L *

K875

K8445 K8445L *

K1075

only for modules I-BOX

only for modules I-BOX

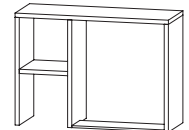
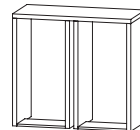
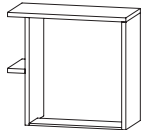
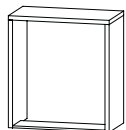

K77 K77L *

K877

K8447 K8447L *

K1077

only for modules I-BOX

only for modules I-BOX

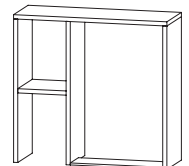
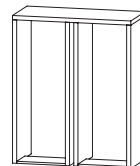
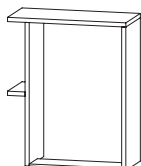
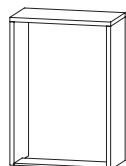

K79 K79L *

K879

K8449 K8449L *

K1079

DRAWERS I-BOX / MILLIMETRICA

Gesso / Greige

* Front lacquered/ internal finish in melamine Gesso, only for Millimetrica lacquered

W.453

W.693

W.853

DRAWERS H.156 Chromed Handle



Front



Wood Th. leather



Wood Th. leather



Wood Th. leather

Code

C42L C42C C42LL * C62L C62C C62LL * C72L C72C C72LL *

Melamine Gesso

Melamine Greige / Brown

DRAWERS H.316 Chromed Handle

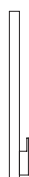

Front



Wood Th. leather



Wood Th. leather



Wood Th. leather

Code

C43L C43C C43LL * C63L C63C C63LL * C73L C73C C73LL *

Melamine Gesso

Melamine Greige / Brown

DRAWERS H.156 Chromed Handle



Front



Glass Th. leather



Glass Th. leather



Glass Th. leather

Code

C42VL C42VC C42VLL * C62VL C62VC C62VLL * C72VL C72VC C72VLL *

Melamine Gesso

Melamine Greige

PULL-OUT TRAYS H.156



Front



Wood Th. leather



Wood Th. leather



Wood Th. leather

Code

C42S C42SC C42SL * C62S C62SC C62SL * C72S C72SC C72SL *

Melamine Gesso

Melamine Greige

BELT RACK

to place inside drawers and trays.



Code

CR4

CR6

CR7

Natural anodized aluminium

DRAWERS I-BOX / MILLIMETRICA

Walnut

W.453

W.693

W.853

DRAWERS H.156 Wooden Handle



Front



Wood



Wood



Wood

Code

C42N

C62N

C72N

Melamine Walnut

DRAWERS H.316 Wooden Handle



Front



Wood



Wood



Wood

Code

C43N

C63N

C73N

Melamine Walnut

DRAWERS H.156 Wooden Handle



Front



Glass



Glass



Glass

Code

C42VN

C62VN

C72VN

Melamine Walnut

PULL-OUT TRAYS H.156 Wooden Handle



Front



Wood



Wood



Wood

Code

C42SN

C62SN

C72SN

Melamine Walnut

BELT RACK

To place inside the drawers and trays.



Code

CR4

CR6

CR7

Natural anodized aluminium

ACCESSORIES

LED Lights (I-BOX)

The kit is complete with sensor for automatic on/off switch of the 4 LED lights.
For modules W.400/480/560mm. only one LED bar is fitted on the right hand side panel

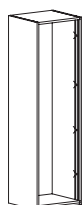

Kit 1 bar

BLED1

For modules W.800/960/1120/1440mm. bars are fitted on both side panels.

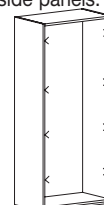

Kit 2 bars

BLED2

Raster W.800 (I-BOX/MILLIMETRICA)

Melamine finish Gesso, Greige, Brown and Walnut.
To be used between two shelves W.762mm. or placed on a chest of drawers with upper closing shelf.

* Lacquer finish only for Millimettrica lacquered

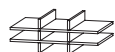

H.320

AR62

AR62L *

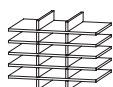

H.640

AR64

AR64L *

Raster W.960 (I-BOX/MILLIMETRICA)

Melamine finish Gesso, Greige, Brown and Walnut.
To be used between two shelves W.922mm. or placed on a chest of drawers with upper closing shelf.

* Lacquer finish only for Millimettrica lacquered



H.320

AR72

AR72L *

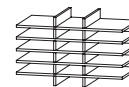

H.640

AR74

AR74L *

Raster W.1120 (I-BOX/MILLIMETRICA)

Melamine finish Gesso, Greige, Brown and Walnut.
To be used between two shelves W.1082mm. or placed on a chest of drawers with upper closing shelf.

* Lacquer finish only for Millimettrica lacquered

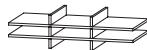

H.320

AR82

AR82L *

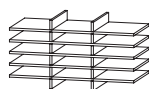

H.640

AR84

AR84L *

Raster W.1440 (I-BOX)

Melamine finish Gesso, Greige and Walnut.
To be used between two shelves W.1402mm. or placed on a chest of drawers with upper closing shelf.

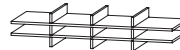

H.320

AR102

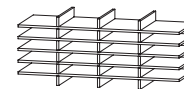

H.640

AR104

Trouser holder (I-BOX/MILLIMETRICA)

Complete with upper shelf thickness 38mm.
Melamine finish Gesso, Greige, Brown and Walnut.
Pull-out frame in anodized aluminium and trouser rack in aluminium with rubber profiles.
Fixed between two side panels of a wardrobe or of a walk-in closet.

* Lacquer finish only for Millimettrica lacquered



W.522

AP4

AP4L *



W.762

AP6

AP6L *



W.922

AP7

AP7L *

ACCESSORIES

Shoe-rack (I-BOX)

In natural anodized aluminium and chromed rails.

To be fitted slanting using the drilling holes of the side panels. It is possible to position two rows of shoes.



W.522

AS4



W.762

AS6



W.922

AS7



W.1082

AS8

Shoe-rack (MILLIMETRICA)

In natural anodized aluminium and chromed rails.

To be fitted slanting using the drilling holes of the side panels. It is possible to position one row of shoes.



W.522

ASC4



W.762

ASC6



W.922

ASC7



W.1082

ASC8

Side raster (I-BOX)

D. 495 Th.38mm.

Fixed to the base and to an upper shelf. Can be made to measure every 80mm. Melamine finish Gesso, Greige and Walnut.

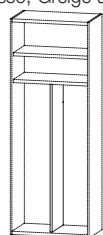

A13

H.max: 2165mm. hinged
2105mm. sliding
Made to measure already
included in the price

Fixed mirror (I-BOX)

W.350 H.1500mm.

To be fitted inside hinged doors W.476 / 556mm. (left or right).

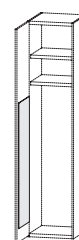

AS11

Melamine Gesso

Melamine Walnut/Greige

Adjustable mirror (I-BOX)

W.375 H.1400mm.

To be fitted inside hinged doors W.476 / 556mm. (left or right).

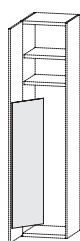

AS36

Adjustable pull-out mirror (I-BOX)

W.380 H.1400mm.

To be fitted on a side panel of a module with sliding door.

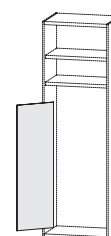

AS37

ACCESSORIES

Pull-out hanger (I-BOX)

D.400mm.

For wardrobes made to measure in depth.

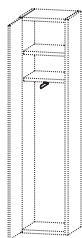

A24

Container with shelves (I-BOX)

H.1243mm.

Made of 6 wooden shelves , n°7 glass shelves, n°2 side rasters, n°1 upper closing shelf.

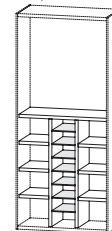

For module W.960

For module W.1120

AC71

AC81

Melamine Gesso

Melamine Walnut/Greige

Pull-out shelf (I-BOX)

Frame in natural anodized aluminium with transparent glass top. Runs on invisible guides.

Maximum weight capacity 20 kg.



W.762

AT16



W.922

AT17



W.1082

AT18

Pull-out shelf with clothes rail (I-BOX)

Frame in natural anodized aluminium with transparent glass top and chromed clothes rail. Runs on invisible guides.

Maximum weight capacity 20 kg.



W.762

AT36



W.922

AT37



W.1082

AT38

Pull-out frame with clothes rail (I-BOX)

Frame in natural anodized aluminium with chromed clothes rail. Runs on invisible guides.

Maximum weight capacity 20 kg.



W.762

AT26



W.922

AT27



W.1082

AT28

ACCESSORIES

Fixed belt rack (I-BOX)

W.420mm., complete with 7 hooks. In natural drawn aluminium with details in opaline. To be fixed on the inside of a hinged door.



APCF

Fixed tie rack (I-BOX)

W.420mm., complete with 28 hooks. In natural drawn aluminium with details in opaline. To be fixed on the inside of a hinged door.



APRF

Fixed scarf holder (I-BOX)

W.420mm., complete with 8 hooks. In natural drawn aluminium with details in opaline. To be fixed on the inside of a hinged door.

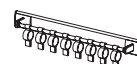

APFF

Pull-out belt rack (I-BOX/MILLIMETRICA)

W.480mm., complete with 8 hooks. In natural drawn aluminium with details in opaline. To be fixed internally on a side panel. For fixing underneath a shelf, use of element SNODO is required **code ASN**

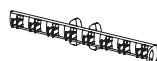

APCE

Pull-out tie rack (I-BOX/MILLIMETRICA)

W.480mm., complete with 32 hooks. In natural drawn aluminium with details in opaline. To be fixed internally on a side panel. For fixing underneath a shelf, use of element SNODO is required **code ASN**



APRE

Pull-out scarf holder (I-BOX/MILLIMETRICA)

W.480mm., complete with 8 hooks. In natural drawn aluminium with details in opaline. To be fixed internally on a side panel. For fixing underneath a shelf, use of element SNODO is required **code ASN**

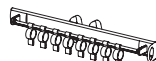

APFE

Connecting element snodo (I-BOX/MILLIMETRICA)

In plastic material finish opaline. Allows the fixing of two pull-out racks: belt rack, tie rack, or scarf holder. To be fixed underneath a shelf.

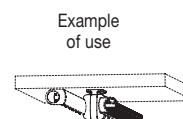

ASN

Boxes H.130mm. (I-BOX/MILLIMETRICA)

W.400 D.480 mm. Pair of boxes in fabric in white colour with trade mark detail in thick leather.



AS16

Boxes H.260mm. (I-BOX/MILLIMETRICA)

W.400 D.480 mm. Pair of boxes in fabric in white colour with trade mark detail in thick leather.

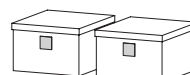

AS26

Clothes' bags (I-BOX/MILLIMETRICA)

W.58 H.95/115 mm. Pair of clothes' bags in fabric in white colour with buttons to adjust in two heights (example: jacket or coat size).



ACS

Coat hangers (I-BOX/MILLIMETRICA)

W.44 H.86mm. each. Pair of wooden coat hangers in oak stained Walnut or varnished white with trade mark, bar in natural anodized aluminium with wooden grip in oak stained Walnut or varnished white, chromed hook.



ACG

